

Hydrotreater Optimisation with Welded Plate Heat Exchangers.

by Peter H. Barnes PBA
Consulting Engineers
Sydney, Australia.

Hydrotreater Optimisation with Welded
Plate Heat Exchangers.

Abstract

For modern Naphtha Hydrotreaters (NHDT) & Gasoil Hydro De-Sulphurizers (HDS), all-welded plate heat exchanger (PHE's) are an attractive option (**see Fig 1**). PHE's used in Reactor Feed/Effluent (F/E) service significantly reduce project Capex & operating costs through high thermal efficiency that delivers 15-20°C hot end approach temperatures & thermal duties to 100 MW in a single shell. On new units, first 5-year operating & project savings totalling US\$10 Million are typical for a 35 000bpsd Gas Oil HDS. Frequently in NHDT/HDS revamps, the PHE's high exchange duty & lower ΔP not only yield large capacity increases without having to up-size charge heater, product cooler or recycle gas compressor, but also reduce energy consumption per tonne of product.

1. Summary.

Packinox Origins : Packinox pioneered industrial application of large scale Plate Heat Exchanger (PHE) on Catalytic Reformer revamps in the 1980's by replacing traditional banks of Shell-&-Tube exchangers (**Fig 2**) with a single bundle, single shell unit providing much closer approach temperatures & lower pressure drop. With 160+ references & almost 400 cumulative operating years, these modern stainless steel PHE's have become the industry standard for Catalytic Reformers & Aromatics plants. Benefiting from uniform 2-phase distribution & no dead-zones due to inherent static mixer effects of the high turbulence, corrugated plate design; these PHE's are manufactured by a unique process that produces plates to 16m long with 2-3x higher heat transfer coefficients than S-&-T's. The result is total exchange duty is one bundle with no intermediate piping losses. (**Fig 2**)

Hydrotreater Adaptation : By the mid-1990's this technology was successfully operating in hydrotreater service (**Fig 3**) after a thorough development program including thermal & mechanical analysis & testing, process studies together with pilot-plant fouling tests. Now in Dec. 1998 there are 21 Naphtha, Gasoil & Pyrolysis Gasoline references (with 27 years cumulative operating experience) again benefiting from reduced plot space & piping with Capex & Opex savings due to close approach temperatures & low pressure drop. These operating hydrotreater PHE's not only reduce capital & energy costs, but their corrugated-plate construction (like a static mixer) also dramatically reduces fouling, while inspection maintenance & cleaning (if required) are readily performed in-situ.

Safer, Cleaner Design-Concept (Fig 9B). The very significant reduction of high-pressure flanges in hot hydrogen service (particularly the elimination of large diameter S-&-T body flanges) greatly reduces combustible vapour leaks & illegal emissions of toxic hydrocarbons & H₂S. Refiners universally see this as a large step forward in plant safety & environmental performance. Hydrotreater unit flue gas emissions of SO_x & NO_x are also reduced because charge heater duty is lower (often zero in fact) with PHE technology. The PHE pressure vessel shell is always substantially cooler than the process flows inside its bundle,

in effect giving this pressure vessel a very high safety factor. The overall reduction in plant complexity due to smaller & fewer equipment items is always welcome, & reduces the chance of mishaps due to human error.

Application & Economics : Motivated by cheaper, cleaner, safer operation than found in older designs, refiners in Asia, the Americas & Europe are increasingly selecting Packinox PHE's to optimise their Hydrotreater units. In both new units & revamps, for Naphtha Hydrotreater (NHDT) plus both Hot & Cold HP separator Gasoil Hydro De-Sulphurizers (HDS), PHE economic benefits are compelling. Typically, the five-year overall cost saving for a new 50,000 bpsd HDS is about US\$10-15 Million. Further benefits accrue from lower maintenance & higher on-stream factor.

2. Mechanical Design.

The cutaway drawing of **Fig 5** illustrates construction of the "High Pressure HDS Packinox" heat exchanger for Reactor Combined Feed/Effluent (F/E) service. It is essentially a large heat transfer bundle (or plate-pack) inside a pressure vessel. The bundle is made of thin stainless steel corrugated sheets formed by underwater explosion, stacked & welded together.

All heat transfer takes place inside the bundle that operates in true counter-current flow & no net circulation takes place in the shell which is simply pressurised by recycle gas compressor discharge. As this is the reactor loop's highest pressure point, the plate pack is always securely compressed by shell gas.

Because the PHE bundle is all welded (no gaskets nor brazing) these exchangers can operate at service temperatures well above those found on hydrotreaters - 550 °C on Cat. Reforming & 620°C for Styrene Monomer PHE. There is no absolute limit on PHE operating pressure other than the pressure vessel shell design rating, however there are limits on differential pressure (dP) between the fluids being heat exchanged. Pressure tests & Finite Element Analysis confirm that PHE bundles can withstand 30 bar "positive dP" from feed to effluent side which is adequate for virtually all known hydrotreaters. By contrast, a small "reverse dP" (effluent > feed pressure) could damage the plate pack, so the plant designer ensures that this can never occur for any foreseeable design case including emergency

depressurising. Hydrotreater PHE bundles are enclosed in a restraining structure of 25mm thick plates clamped by tie-rods. This provides a margin of 1 bar reverse dP protection for cases of unexpected plant failure or mis-operation.

Four expansion bellows compensate for differential thermal expansion between the hot stainless steel bundle & the cooler low alloy pressure vessel. Top & bottom end manholes permit in-situ access for inspection & maintenance (without exchanger dismantling) & facilitate bellows replacement should this ever be needed.

As studies on total HDS unit heat integration underlined the importance of considering efficient heat integration between Reactor & the Stripper loops, Packinox developed a second high heat recovery configuration - the "Low Pressure Stripper Packinox PHE". As Stripper pressure & temp. are considerably lower (240°C/5 bar) than reactor pressure (340-380°C/40-80 bar) a pressure vessel is not required for these virtually 100% liquid Stripper Bottoms / Feed services. Instead a set of bolted cross-beams securely clamp & compress the plate-pack (**Fig 6**).

3. Process Operation, Control & Integrity Aspects.

Although the HDS Packinox exchanger is a relatively new piece of equipment, its development has been very thorough with in-depth consideration of a wide range of application issues. All technical questions raised have been well answered, with some key areas reviewed below.

3.1 Close Approach Temperatures & Low Pressure Drops.

Both HP Reactor & LP Stripper PHE's employ exactly the same type of corrugated stainless steel heat transfer plates to provide high turbulence with low pressure drop at all points within the bundle. This results in :

- Very high heat transfer coefficients (2 to 3 times S-&-T coefficients)
- Approach temps. of 10-20 °C (cf. ~50 °C typical-best for S-&-T's)
- Negligible fouling ("as new" after 3 years service - **Fig 8**).
- Delta-P each side only ~0.7 bar (cf. 3-4 bar for train of S-&-T F/E exchangers)

As the lower approach temperature of HDS PHE's recover more heat from the reactor effluent into the combined feed so less fired heater duty is required (**Fig 4**). This reduces fuel gas consumption, shortens furnace tubes (with less furnace ΔP), plus reduced air cooler size (again, with less air cooler ΔP). The lower heater & air cooler ΔP combines with the PHE's own lower pressure drop (both circuits) to significantly lower the re-compression head required at the recycle gas compressor (often saving over 1 MW in power consumption).

3.2 Reactor Exotherm Control.

Gasoil HDS reactions release considerable heat, usually in the range 1-3 MW per 1000 tonne/day Gasoil feed. Plant operators must ensure that reactor outlet temperature (T_o) does not rise above a pre-set level. If exotherm goes up by say 1 MW (e.g. with different feed); one obvious way to compensate is by tuning the heater down by 1 MW. The fact that PHE technology allows HDS charge heater normal duty to be greatly reduced (even to zero) may seem at first to remove a vital degree of control.

However this is not so, since for all design cases, T_o can be safely contained by manual or automated actions to :

- increase quench gas flow to the reactor bed ;
- reduce heater duty (to lower reactor inlet temperature, T_i) ;
- partially bypass the F/E exchanger (to further lower T_i as required).

Beyond these basic corrective actions to restore reactor heat balance, the operator may line up a cooler feed, or increase the duty of external heat sinks if/when provided (e.g. Reactor loop heat recovery into stripper feed or into any steam generators).

Bypassing the large-duty F/E exchanger offers a much greater potential to lower T_i than reducing fired heater duty (which contributes a much smaller heat flux). For this reason, HDS Packinox reactor F/E exchangers are installed with a liquid-feed bypass control valve. Large fired heaters are definitely not required to control reactor temperature runaways!

When exotherm decreases, the capability of the HDS process unit to maintain full design feed rate depends on

the charge heater's design margin (above normal duty), not its total Megawatt size. Thus a modern HDS with a relatively small furnace (e.g. 12 MW, including 7 MW margin as in **Fig 11B**) more readily copes with low exotherms than an older unit with a charge heater twice the size but with less design margin (e.g. 25 MW, but only 2 MW margin as in **Fig 11A**).

3.3 HDS Charge Heater Duty for Start-up (Fig 13 A)

For most HDS units the target heat-up rate is in the range 20-40 °C/hr. More rapid heating can cause flange leaks & other problems due to excessive or uneven thermal expansions, while slower rate may unduly delay the start of profitable normal operation. Cold start up to normal operating temperature in 8-16 hours would generally be considered satisfactory.

For the case study shown in **Figs 11A/11B**, the heater design size is halved (from 25 to 12 MW) when multiple S-&-T exchangers are replaced with 2 PHE's. However transient analysis (ref.2) shows that heat-up times are virtually the same, remaining in the range 11-12 hours. This is essentially because the Packinox option, with its close-approach design, rejects far less heat via the reactor effluent air cooler. Instead it directs effluent heat efficiently back into feed so that more net heat from H1 is recycled back from effluent into reactor warm-up.

The conclusion is clear; while a certain minimum HDS charge heater size is required for economic heat-up rates, this minimum can be relatively small when a "Close Approach" exchanger system is employed. Big heaters are not needed for warm-up or steady operation, they only increase emissions & risk levels, as well as costing more to build, operate & maintain.

3.4 Charge Heater 2-Phase Distribution

The velocity necessary for homogeneous 2-phase flow determines HDS heaters heater tube number, but as lower-duty heaters have shorter tubes, so heater ΔP is less. While symmetrical pipe branching (not heater ΔP) to & from the heater is the key requirement for ensuring equal 2-phase flow to all parallel heater passes.

3.5 HDS Emergency De-Pressuring.

A plant fire may trigger Emergency De-Pressuring action (EDP). After cutting heater fuel, Gasoil feed & H₂ supply, HDS reactor circuit pressure would typically be lowered to about 7 bar over some 15 minutes by a controlled relief from the HP separator. This minimises pressure vessel stresses in case flame impingement or radiation overheats wall temperatures. During this short time the refinery flare looks awesome due to the apparently huge release of fuel from the HDS reactor circuit. It is not hard to imagine an extreme differential pressure (dP) developing inside the reactor circuit, possibly damaging certain internals such as the PHE plate-pack.

The detailed analysis (in ref.2) of a classic 15-minute EDP event shows that PHE cold-end dP does indeed rise, but only by about 3 bar during the first minute after the EDP valve is opened. Thus maximum dP is still way under the Packinox mechanical design value of 20-30 bar where still acceptable plate deflections of 0.01 mm are computed. After the first minute Packinox dP slowly decays again as oil inventory is swept into the HP separator. Once the recycle gas compressor is shut down (due to low suction pressure) ; PHE dP actually falls below its normal operating value. Plant design & operation is such that dP is always in the positive direction, compressing the plate pack together.

The fundamental reason for the relatively low (3-bar) rise in PHE dP during EDP is that, while the flow to flare (e.g. ~ 170 t/d) may appear large & spectacular, incremental gas flow rates (& hence pressure drops) inside the unit are relatively small compared with the normal operational flows (e.g. ~ 9,000 t/d hot vaporised oil & recycle gas) !

The potentially more harmful "reverse pressure differential" cannot occur unless the Packinox shell-space is somehow rapidly de-pressured (below internal bundle pressure) by a mis-operation or hardware failure. In theory the bundle might then rupture with a weld crack between two outer plates. If so, repair is possible by re-welding the crack in-situ. The risk is remote however as hydrotreater PHE bundles are enclosed in a restraining structure of 25mm thick plates clamped by tie-rods. This provides a margin of 1 bar reverse dP protection for cases of unexpected plant failure or mis-operation.

3.6 Low Fouling Susceptibility

Hydrotreater feed circuit olefinic & peroxide gum fouling are well known on S-&-T exchangers, yet PHE's have reduced susceptibility to this phenomena – why? Due to constantly varying canal section & 1000's of fluid direction changes in the plate canals, PHE's deliver a uniform, turbulent mix that scrubs every surface in the bundle.

Unlike F/E exchangers in Naphtha Hydrotreaters or Reformers, Gasoil HDS exchangers have no dry point; enough liquid Gasoil is always present to wet & vigorously wash all heat transfer surfaces. This, plus the “static mixer” effect of PHE plate corrugations, ensures that everywhere within the HDS bundle there is :

- Absence of stagnant zones,
- Absence of dry zones from phase stratification,
- High gas/liquid turbulence,
- Homogenous gas/liquid distribution.

Even with “dirty feeds” (HGO, VGO & 70%HGO/30%LCO mixes- see **Fig.7**) this reasoning is supported by the excellent low-to-zero fouling results from Japanese pilot plant tests made by JGC in 1993 & Brazilian in-refinery slip-stream pilot tests made during 1998 by Petrobras. JGC's testing showed minor fouling could only be produced by artificially saturating Gasoil feed with air. Cleaning with solvent wash & low-pressure steam restored clean exchanger performance.

Since 1993, commercial Gasoil service has confirmed PHE's low fouling, as a Russian unit at the Yukos refinery (Novokufbyshevsk) operates with a constant hot approach 12°C below design on atm-gasoil / cycle-oil feed-mix (**Fig 8**).

Precautions are necessary however on NHDT, as the feed mixture is heated through a dry point so no liquid remains to ‘scrub’ the plate. Whilst fouling is very low with normal ‘clean’ Naphtha feed, attention must be paid to avoid ‘dirty components’ in the feed (heavy ends, olefins, O₂ or scale).

NH₄Cl salts can deposit in NHDT & cold separator HDS F/E exchangers, causing effluent circuit fouling raising exchanger ΔP. Deposits form when reactor effluent cools to 180-80°C depending on the N & Cl levels in feed & fresh-gas. On-line washing by injecting O₂-free water into the effluent stream readily restores the PHE's original ΔP.

An alternative approach frequently employed new units, is removing HCl from reformer produced fresh-gas with Alumina guard beds as this avoids formation of NH₄Cl in the exchanger.

3.7 Solids Migration Protection

Deposition of iron corrosion products & catalyst fragments has happened at the inlet face of the Yukos HDS exchanger, causing an increase of effluent-side ΔP but no deterioration of heat transfer performance (see **Fig 8** again). Evidently any particle small enough to enter the slot between plates simply passes through the bundle to settle in downstream equipment (probably the rundown tank as there is no coalescer at Yukos). After the mounded solids at Yukos were removed by vacuum cleaning, exchanger ΔP returned to its original design value.

Whilst nominally significant quantities of solids should not be found migrating in hydrotreaters, emergency strainers are now included in the hydrotreater PHE feed & effluent inlets to facilitate removal of any solids that do migrate by just removing a pipe spool.

3.8 Corrosion Issues in Hydrotreater Service - (Fig 9 A) :

To minimise any high temperature attack by H₂/H₂S, PHE bundles are all austenitic stainless steel .

Employing austenitic stainless steel requires certain simple precautions to provide many years of corrosion-free PHE service to avoid the potentially corrosive combination of particulate-deposits, chlorides, oxygen & free-water within the bundle. These issues are discussed below.

Corrosion during normal operation could theoretically occur in the PHE by:

- Cold-end, effluent-side pitting below moist deposits of ammonium salt. When such hygroscopic salts are likely to deposit, wash water is injected upstream of the water dew point to prevent “under deposit corrosion” via mid-bundle injection points. The HE feed side is not prone to ammonium salt deposits as it receives recycle gas after water wash has scrubbed out remaining ammonia made in the HDS reactor.
- Cold-end, feed-side pitting beneath any moist solid deposits. (Beyond the cold end, plates are too hot to be moist). Such galvanic corrosion may be promoted by corrosion scale, chlorides, free-water & oxygen in the feed

mix. While most scale passes through the PHE to the reactor, traces may deposit in any dead zones, for this reason the PHE uses a design that eliminate dead zones. (Note: Scale & O₂ are removed by the reactor & so don't affect the HE effluent side).

Simple effective preventative measures against pitting include :

- 1) Feed surge drum/water boot (or coalescer) to remove entrained (potentially salty) free-water from feed.
- 2) Fine-mesh feed strainers to remove any corrosion product particles from the feed
- 3) Alumina guard beds at the Reformer to remove HCl traces from HDT/HDS fresh gas.
- 4) Gas blanketing or floating roofs on feed tanks to prevent oxygen absorption from air/oil contact.
- 5) A buffered wash of both HE sides at shutdown to remove any possible small deposits.

Corrosion during shutdown / regeneration could occur in the PHE by:

- Pitting under then-cold deposits in any part of the bundle if exposed to humid air during a prolonged shutdown. Before opening the PHE to atmosphere the PHE bundle is washed with buffered O₂-free water to remove any small deposits that might promote galvanic "under deposit corrosion" in humid air.
- Condensation of acidic regeneration off-gas in the stainless steel Packinox bundle during N₂/air catalyst de-coking. To regulate the bundle outlet temperature safely above acid dew point, the Packinox feed-side bypass valve is nudged open as required. This precaution applies only at refineries employing on-site regeneration.

It is worth noting that PHE's have inherent low susceptibility to stress corrosion cracking as the explosion forming method used to emboss the corrugations on the stainless steel plates & the bundle wall welding method are proven to produce virtually no metal sensitizing or residual manufacturing stresses.

4. HDT Designs - Case Study.

4.1 PHE Economics – New Unit HDS

Eight studies for refineries in Asia, Europe & the Americas (**Fig 13 B**), demonstrated average 5-year total benefits of US\$ 10Million for 35 000 bpd - the average study capacity.

4.1 Cold High Pressure Separator HDS.

In 1997 a Taiwanese refiner ordered Packinox PHE's (rather than S-&-T exchangers) for two 65 000 bpd Gasoil HDS units after a careful re-design by the licensor. Total economic impact of this change is estimated at US\$ 49Million. These savings comprise a 20 MW energy saving (fuel & electricity) for each unit valued at us \$ 3.3 Million/year. (**Fig 14 A**), or US\$ 16Million for the first 5 years of operation. Installed capital savings of US\$8Million result from fewer & smaller installed equipment items. Only 12% of this Capex saving is directly due to lower F/E exchanger costs; 88 % is due to "spin-off" effects (**Fig 14 B**). Thus the total 5-year benefit is 2 x US\$ 24.5Million.

Fig 11 A shows the 8600 t/d S-&-T base case, while **Fig 11 B** highlight changes in plant equipment & plant energy consumption when 2 PHE's replace trains of key S-&-T exchangers in this Cold HPS-type HDS.

The "temperature / enthalpy diagram" of **Fig 4 B** broadly illustrates the principles of improved heat recovery from the reactor loop of a simple cold-separator HDS (with no E8) when PHE's are employed to generate closer approach temperatures

Flow diagram abbreviations used are as follows :

H	Charge Heater
R	Reactor
A	Amine H ₂ S Absorber column
K	Recycle Gas Compressor
S	Stripper Column
W	Wash water injection
E1	Stripper feed/bottoms exchanger
E2	Reactor feed/effluent exchanger
CHPS	Cold High Pressure Separator
HHPS	Hot High Pressure Separator

The table **Fig 10** gives the overall plant heat balance & the heat input (Q_i) required to raise feed mix (cold Gasoil + cold recycle gas) to reactor inlet temperature. This is a useful crosscheck, since Q must be the same for all design cases. Similarly, this table also shows the heat removal (Q_o) to lower reactor effluent from 380 °C to 50 °C. All energy data is given to the nearest Megawatt. (1 MW = 1.163 million kcal / hr = 3.41 million Btu / hr).

The **Fig 11 B** shows the result of installing two Packinox exchangers (E1 & E2) in place of former S-&-T trains in the same service. Due to much lower PHE approach temperatures, the combined effect of E1 & E2 raises charge heater (H1) inlet temperature from 305 °C to 350 °C. This reduces H1 operating duty by about 80 % ($\Delta = 23-5 = 18$ MW). However H1 design duty is cut by only 50 % to retain the same unit warm-up rates for start-up.

Basing H1 process duty on Gasoil heating in a radiant cell whose "furnace efficiency" is typically 65% (or less), the above 18 MW reduction saves about 48 tonne/day fuel gas (assuming LHV equivalent to natural gas). With local gas prices at US\$ 160 /tonne, using 340 stream days per year, the economic value of this reduction in H1 duty is thus US\$ 2.6Million/year.

Total pressure drop around the overall HP reactor circuit falls from 18 bar to only 11 bar. This is because the single E2 Packinox has a much lower ΔP than the former train of 6 x E2 S-&-T exchangers, heater H1 needs only half the tube length (hence half the ΔP) & the 40% reduction in E3 air cooler duty also reduces its ΔP . For the same total flow of recycle gas, power consumption of compressor K1 thus drops by 1.5 MW (from 3.7 to 2.2 MW). With local electricity priced at US\$ 60/MWh, the economic benefit of this ΔP reduction is US\$ 0.7Million/year.

On this project, total resulting 'enercon' from using PHE's is worth $(2.6 + 0.7) =$ US\$ 3.3 Million/year.

Capital costs are also significantly reduced due to :

Fewer large heat exchangers	8x S-&-T's replaced by 2x PHE's
Smaller charge heater design duty	25 MW replaced by 12 MW
Smaller total air cooler design duty	50 MW replaced by 37 MW
Smaller RG compressor	2 casings replaced by 1 casing
Smaller electric driver for K1	4MW replaced by 2.5MW
Less overall civil work, piping & plot space	1050 m2 replaced by 850 m2

Installed capital cost is then reduced as follows (NB. Actual heat exchanger cost savings are only 12% of the total ; far greater capital savings accrue from spin-off benefits elsewhere) :

Heat exchangers	US\$ 0.9 Million
Charge heater	US\$ 2.2 Million
Air cooler design duty	US\$ 2.7 Million
RG compressor & driver	US\$ 1.9 Million
Total	US\$ 7.7 Million

Five-year Life Cycle Total Savings are thus $(5 \times 3.3 + 7.7) =$ US\$ 24 Million.

4.2 Hot High Pressure Separator HDS.

For the same feed & reactor conditions, **Fig 12 A** shows an alternative hot separator design based on S-&-T exchangers. This widely used design concept already reduces normal duty of charge heater H1 from 23 MW (in **Fig 11 A**) to only 10 MW.

Again, **Fig 12 B** is derived from **Fig 12 A**, to show that the E1 & E2 exchanger banks (containing 10 bundles in total) can be replaced with just 2 Packinox exchangers with closer approach temperatures. Normal operating H1 duty is then reduced to zero! The unit runs iso-thermally on the reactor's 22 MW exotherm. The burners in H1 can now be shut-off & the charge heater bypassed to save a further 2.2 bar ΔP over the reactor loop.

Total energy savings (10 MW fuel + 0.8 MW elec.) for **Fig 12 B** relative to **Fig 12 A** are calculated this time to be ~ US\$ 2 Million/year. Installed capital cost savings are estimated at about US\$ 4 Million, giving a 5-year life-cycle total benefit (for PHE relative to S-&-T) of ~ US\$14 Million.

While 40 % lower than the savings of the previous cold-separator example, this sum is still substantial, & excludes subtle benefits in areas of safety, emissions, maintenance & on-steam time. With these factors included, plus an allowance for escalating energy prices, the 5-year total benefit for this Hot-Separator HDS could easily rise to US\$ 15~20 Million.

5. Gas Oil HDT Revamps - Case Study.

Again, selected from commercial revamp projects studied, the case below provides a typical example of how superior energy conservation of a PHE both saves fuel & assist the refiner to achieve capacity increase targets at minimal capital cost (see Fig 16).

The Fig 15 A shows the existing 5 600 t/d (\approx 42 000 bpsd) Gasoil HDS of a European refinery. The refiner needs to raise capacity 30% to 7 200t/d to respond to the increase in automotive Gasoil demand. The major unit bottleneck is pressure drop over the charge heater ("H1"). Recycle gas compressor constraints are met at a combined-feed intake of 6000 t/d to the heater.

A third party revamp design showed 7200 t/d could be run by installing 3 large, horizontal S-&-T exchangers ("E5 - A, B & C") in parallel with existing E2. This option required H1 to be kept at maximum design capacity (17MW), with outlet temperature raised to 395°C. The Effluent air cooler ("E4") would also need to be operated at its 18MW maximum duty.

Packinox proposed an alternative PHE revamp design whose results are summarised in Fig 15 B. In this case, not only was the 7 200t/d target met, but also the heater bottleneck was totally removed. As this scheme drops heater flow to 3 600t/d, H1's ΔP is lowered 50% with its thermal duty reduced 9MW. Apart from saving ~US\$ 1 Million/year in fuel costs, this option provides the flexibility to eventually run the HDS unit above 7 200t/d without being constrained by H1 or air cooler E4.

The table Fig 16 gives equipment heat duties & overall heat balances of the HDS (for existing unit & for both revamp options). The single PHE duty (43MW) is about double that of the entire bank of 6 S-&-T's (21MW). This is not difficult to achieve with a PHE as the heat transfer coefficient is much higher, furthermore the single-vessel PHE installed cost estimate was less due to its more compact construction that requires far smaller plot space for installation (4 x 4m) & the total elimination of intermediate piping.

In summary, revamping this HDS with just a single PHE allows the unit to run 30% more feed while using 45% less fuel than at present, at a relatively low capital cost.

6. Naphtha HDT - Different Considerations.

Naphtha Hydrotreater (NHDT) units, while very similar in reactor function to Gas Oil Hydro de-sulphurizer (HDS) units, also have subtle but important differences which affect the way heat exchangers are best utilised (see Fig 3).

Key distinctions are:

- 1. Reactor Phase Condition** - Naphtha feed is 100% vapour inside the NHDT reactor, unlike Gasoil that is only partially vaporised & runs in "trickle phase" through HDS catalyst bed. For NHDT's only, a hydrocarbon transition to/from 100% vapour takes place usually in the feed/effluent (F/E) heat exchanger.
- 2. Feed Dry Point** - The NHDT feed mix of liquid naphtha & recycle gas totally evaporates within the F/E exchanger at the so-called "dry point". Beyond this point there is no longer turbulent liquid scrubbing to inhibit deposition of trace contaminants such as gums or solids. NHDT exchangers are thus potentially more prone to feed side fouling than HDS exchangers which are totally wetted & 'washed' by Gasoil.
- 3. Effluent Dew Point** - Hot reactor effluent enters the NHDT exchanger as a vapour that first cools & then starts condensing at its "dew point". Prior to this point removing 'sensible heat' from the effluent stream cools the vapour. Beyond the dew point cooling the effluent requires more heat to be removed per °C of temperature drop. This is because cooling now requires both 'latent heat of condensation' for the liquid being formed in addition to 'sensible heat' from cooling both the vapour & liquid. Thus the exchanger Duty vs Temp. (Q/T) curve suddenly changes slope at the dew point with a distinct kink or knuckle in the Q/T curve.
- 4. Heat Exchanger Pinch Point** - Because of the wet/dry transition points on both feed & effluent sides, both Q/T curves are kinked in NHDT F/E exchangers. This

results in a minimum temperature difference between the feed heating curve & the effluent cooling curve – the pinch point. Pinch point temperature difference is always less than the apparent difference across the hot & cold ends of the exchanger between the exchanger's inlets & outlets (Hot Approach & Cold Approach Temperatures - HAT & CAT). With a hypothetical infinite heat transfer area exchanger pinch point ΔT would decrease to zero (i.e. the Q/T curves would finally touch) the HAT & CAT would still be significant.

With NHDT units, the HAT for maximum economic exchanger heat recovery is around 30°C (due to «pinch») compared to 15-20°C for HDS units which have no wet/dry transition points.

5. Reactor Product Processing – HDS – With HDS units liquid from the reactor product high pressure separator is virtually the finished product as it just goes via a basic steam stripper (to remove H₂S & light ends) & then runs down as cold as possible (via a dryer) to finished product storage. On this scheme high exchanger efficiency is very beneficial for stripper (or reactor) feed/ stripper bottoms service as it minimises heat loss out of the HDS process unit (to atmosphere) in the final run down cooler. Higher efficiency stripper exchangers save net fuel on the HDS reactor charge heater (the unit's only fired heater) as the HDS reactor & stripper loops are heat-integrated with a portion of reactor exotherm heat being exported to the stripper loop (see Figs 11 & 12).

A higher efficiency PHE stripper exchanger reduces charge heater firing because:

- On a Cold HPS (Fig 11) more stripper heat is exchanged back from hot stripper bottoms into cold stripper feed reducing the 'heat spike duty' required from the reactor effluent. This allows more reactor exotherm to heat reactor feed directly so charge heater inlet temp is higher.
- While with a Hot HPS (Fig 12) more stripper bottoms heat is exchanged directly into liquid reactor feed. As the source of Hot HPS heat is running hot

reactor effluent directly into the stripper, the higher efficiency stripper PHE recycles more of this heat back into reactor feed pre-heat again increasing charge heater inlet temp.

It is worth noting that the impact of this 'secondary exchanger' is such that on the most thermally efficient HDS designs the Stripper PHE may have more surface than F/E PHE.

6. Reactor Product Processing – NHDT – By contrast on NHDT units, high-pressure separator liquid is only an intermediate product requiring further high temperature processing. Hydrotreated Naphtha must be de-butanized in a well re-boiled distillation column (or "stabiliser") to remove butane-minus, H₂S & water (to <1ppm) & the high re-boil duty required makes a 2nd fired heater inevitable. Hot stabiliser bottoms then go direct to the next process unit – a naphtha splitter or reformer – avoiding cold storage to stop water ingress from air contact & to cut stock holding costs. Unlike HDS units, the NHDT's fired re-boiler & the desire to make warm product eliminate incentives for close approach temperature outside the reactor loop & heat integrating the reactor loop with the down stream processes.

The impact is similar to a catalytic reformer PHE, minimum NHDT charge heater duty results from the highest duty F/E PHE.

7. Commercial Experience

(see Fig 17 & 18A)

The first commercial HDT PHE started-up in Oct-93 on a Belgian NHDT maintaining 29°C hot approach temperature, (cf. design value of 45o). This was followed by a Gasoil HDS PHE in Russia in Dec-93, with 28°C hot approach (cf. 40°C design). Here it was confirmed that catalyst migration to a PHE inlet face can be readily removed to fully restore PHE ΔP & that if the plate-pack splits due to reverse dP from mis-operation, it can be repaired by welding in-situ. This Russian client ordered a similar PHE to revamp their 2nd HDS unit. In Japan Mitsui revamped their 2nd stage pyrolysis gasoline hydrogenation with a PHE that allows the unit to run

auto-thermally - fired heater off-line. On a Lithuanian NHDT, high N & Cl in feed produces NH₄Cl fouling raising PHE effluent-side ΔP to 1.5 bar in 2 weeks, periodic water injection reduces ΔP back to 0.3 bar in a few minutes.

Of the 21 PHE hydrotreater references 10 have entered service & 11 are under installation or fabrication (**Fig 19**). 13 are capacity increase revamps & 8 are for new units, with 13 for NHDT & 8 for Gasoil-Kero HDS. Applications include UOP & IFP licensed hydrotreaters plus new units & revamps of cold separator HDS's. Feed types & blends range from atmospheric Naphthas & Gasoils, Pyrolysis Gasoline to mixtures containing cracked feeds such as Visbreaker & Coker Naphthas, FCC-Cycle Oils & Coker Gasoil. Since 1993, some 27 years cumulative operating experience confirm PHE efficiency & reliability.

This commercial experience demonstrates that PHE's are a reliable, safe & leak-tight choice for Hydrotreater service. They supersede conventional shell & tube exchangers & can save refiners \$ Millions on new units & revamps (**Fig 18 B**).

Bibliography.

1. "Packinox: Economic & Environmental Advantages of Welded Plate Feed Effluent Heat Exchangers in Refining." Paper AM-95-19, 1995 NPRA Annual Meeting, San Francisco.
By : Francois R. Reverdy, VP Marketing Packinox Inc., Reistertown, Maryland, USA &: Michael G. Sachs, Refinery Manager, Belgian Refining Co., Antwerpen, Belgium.
2. "Packinox in HDT/HDS Service - Devel., Process Issues, Economics & Field Experience". Client Information Booklet-Brochure, Packinox S.A., First Edition, March 1996.
By : Malcolm Kaub, Packinox Sales Engineer, SE Asia & Australia/NZ Region.
& : Peter H. Barnes, Technical Director, PBA Consulting Engineers, Sydney, Australia.

"The Author".

Peter Barnes graduated in chemical engineering at Melbourne University, Australia in 1964 & joined the Shell Company as a process engineer at its Geelong Refinery. After a variety of assignments in Australia, South America & Europe, he returned to Geelong in 1978 to serve as Chief Technologist.

In 1984 Barnes moved to Holland with Shell International as Department Head in charge of Development & Technical Service for Fluid Cat Cracking & Naphtha/Light ends Upgrading. During this 4-year period he became enthused by the Packinox heat exchanger & promoted its wide application in Shell's Platformers around the world.

After his next Shell position as Technology & Planning Manager at Clyde Refinery, Australia, he became a director of PBA Consulting Engineers in 1994.

Peter Barnes is a Fellow of the Institution of Chemical Engineers. He received the 1993 Esso Excellence Award for "Significant Contributions to Innovation in Chemical Engineering".

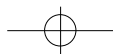

Hydrotreater Optimisation with Welded Plate Heat Exchangers

“Reliable, safe & profitable”

- Paper
- Heat Exchanger Description
 - Fouling & Corrosion
 - Environmental & Operation
 - Economics & Reference List

Fig 1 A

Packinox Plate Heat Exchanger Performance

- Excellent 2-Phase Distribution
- True Counter-Current Flow
- All in one bundle, low DP
- Static Mixer – No Dead Zones



- High Heat Transfer Coefficient
- Close Approach Temp.
- Low Pressure Drop
- Very Low Fouling Rates

Fig 1 B

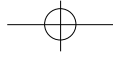

Plant Layout

- Less Plot Space
- Less Piping
- Fewer Flanges

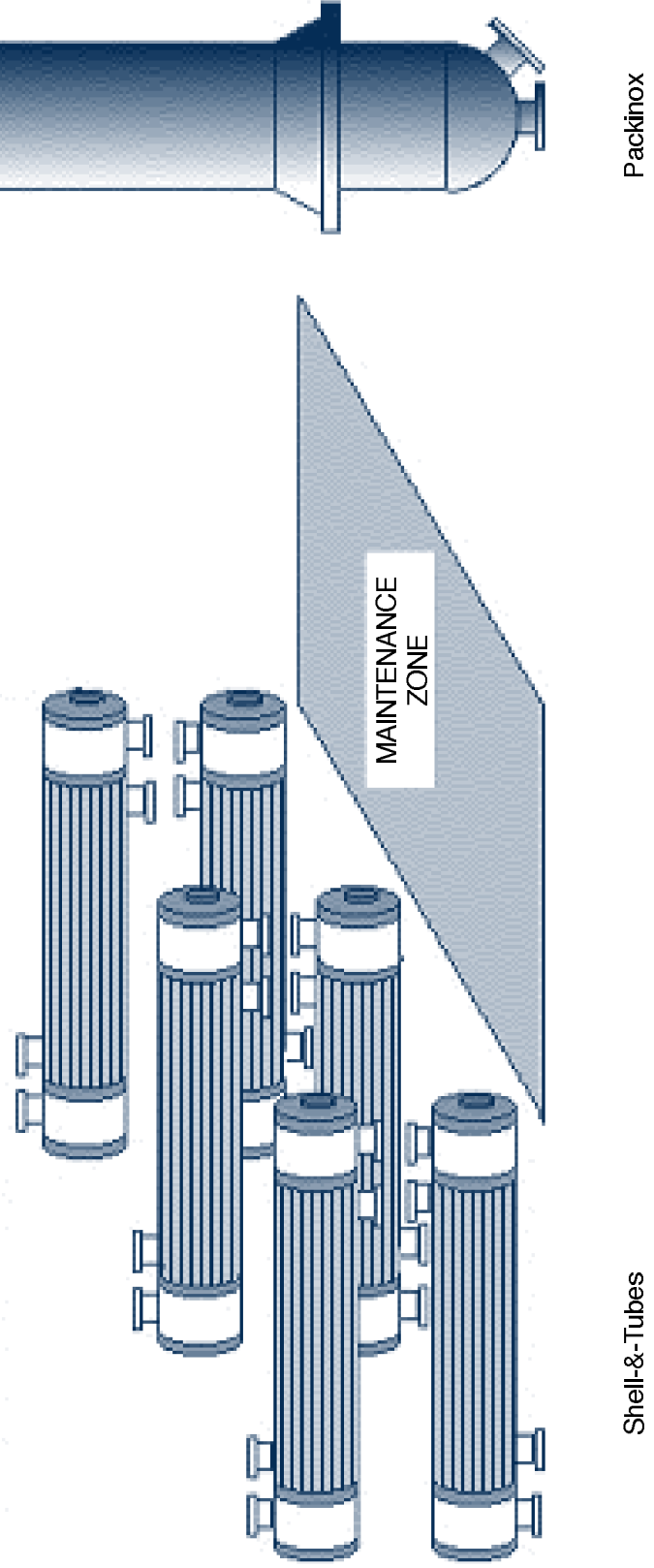
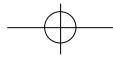

Fig 2



Packinox in the PFD

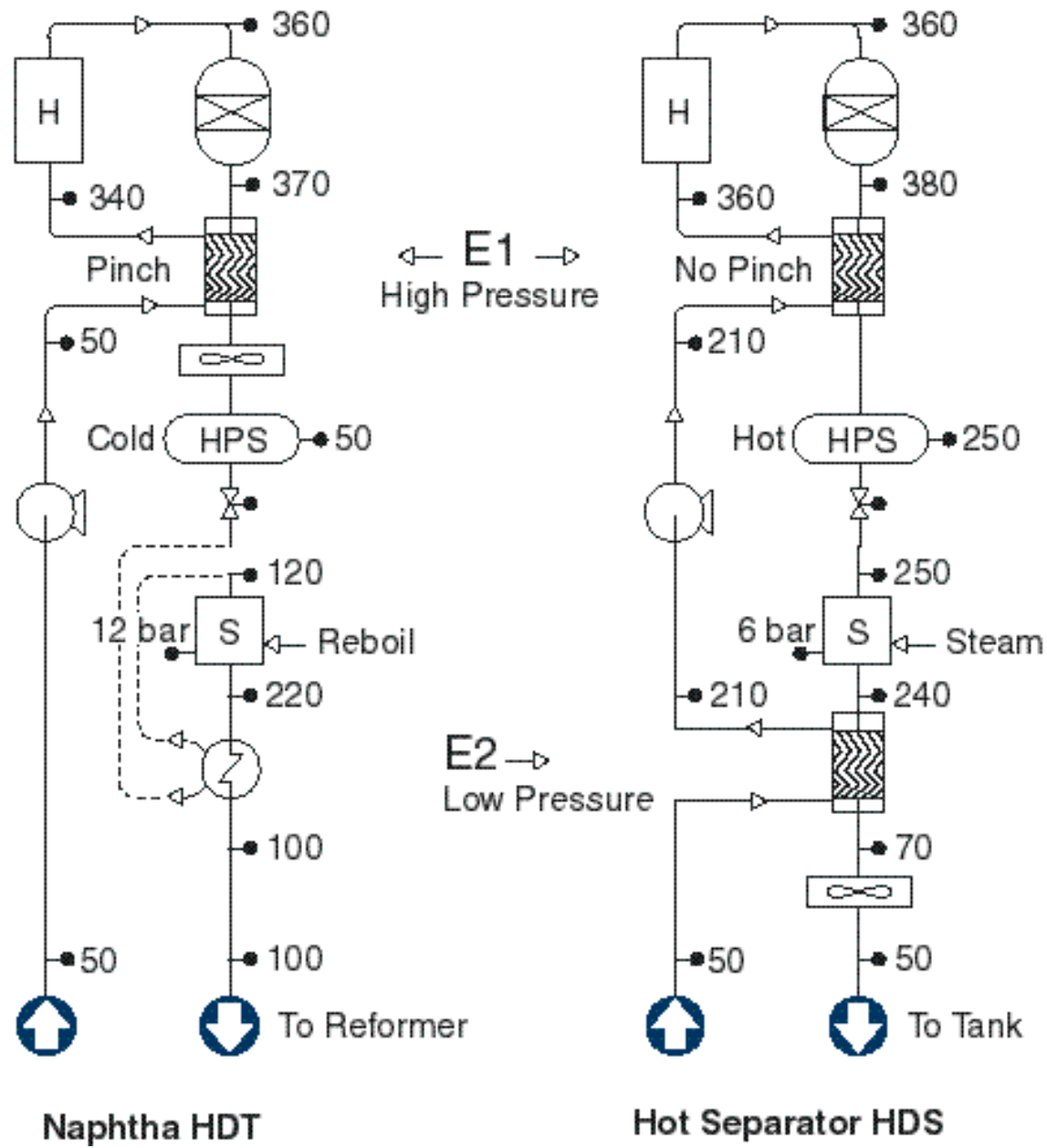
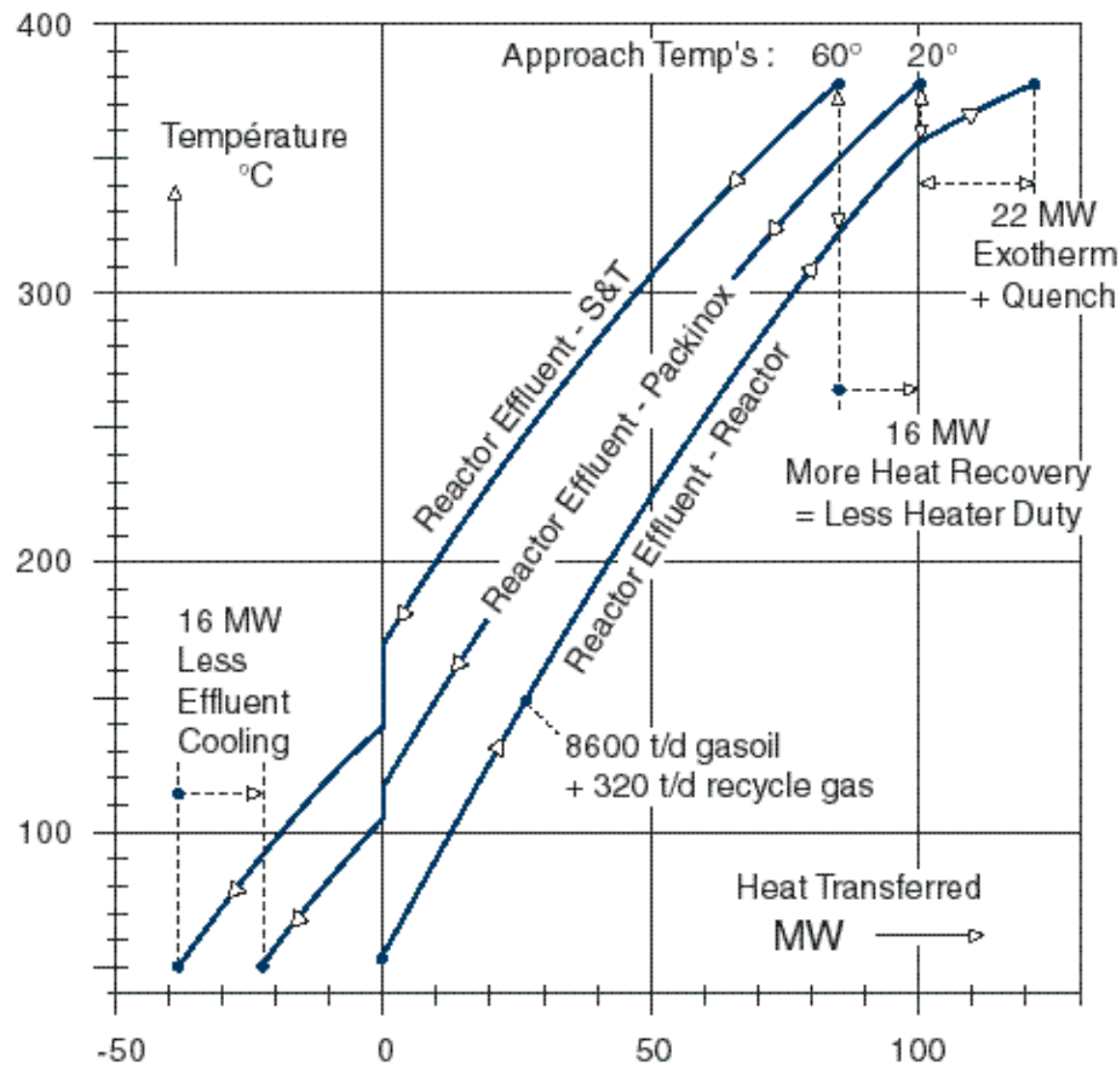

Fig 3

Heat Recovery Diagram - Cold Separator HDS (without E8)



	S & T	Packinox	Saving
Hot Approach °C	60	20	
Heat Recovered MW	84	100	
HP Cooler MW	38	22	16
Charge Heater MW	16	0	16

Fig 4

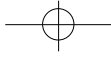

High Pressure HDT Packinox for Reactor Feed / Effluent

Corrugated SS Plates
All Welded Plate Bundle, 10 000 m² +
Inside a Pressure Vessel

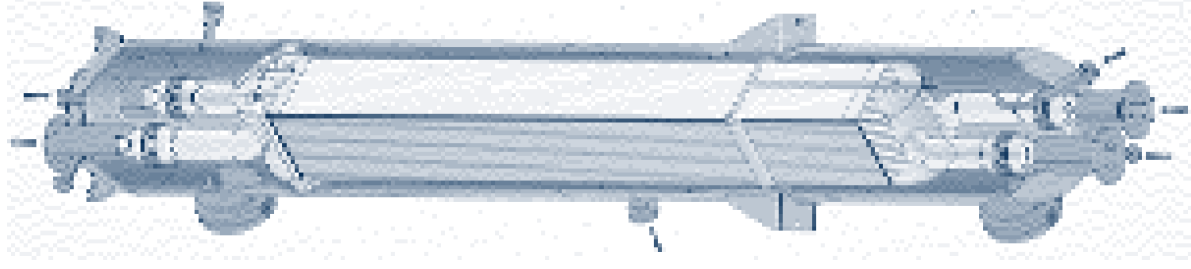
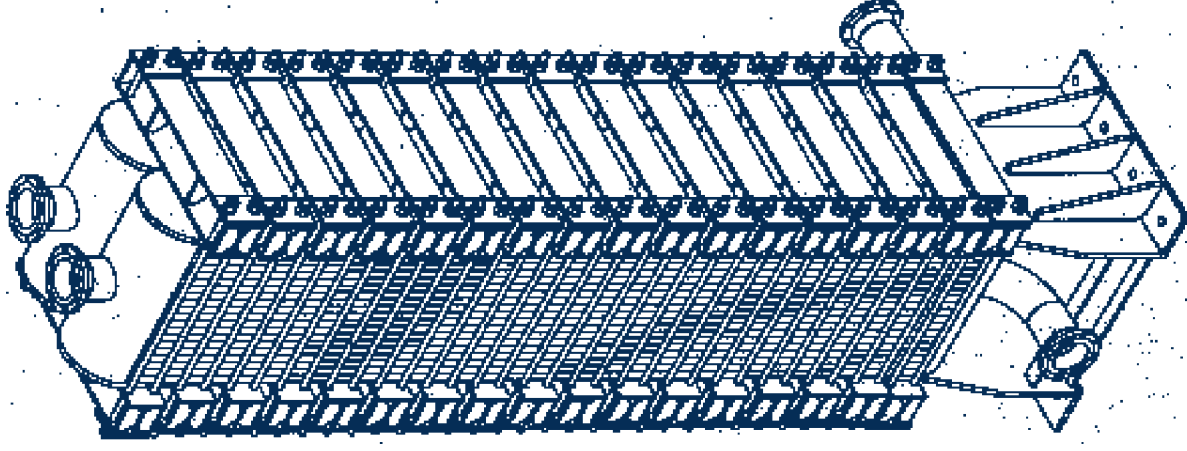
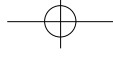

Fig 5



Low Pressure HDT Packinox

- for Feed / Stripper Bottoms
- or Stripper Feed / Stripper Bottoms

Corrugated SS Plates
All Welded Plate Bundle
Bolted Cross Beams

Fig 6

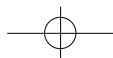

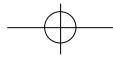

Pilot Plant Fouling Test Packinox vs. S&T

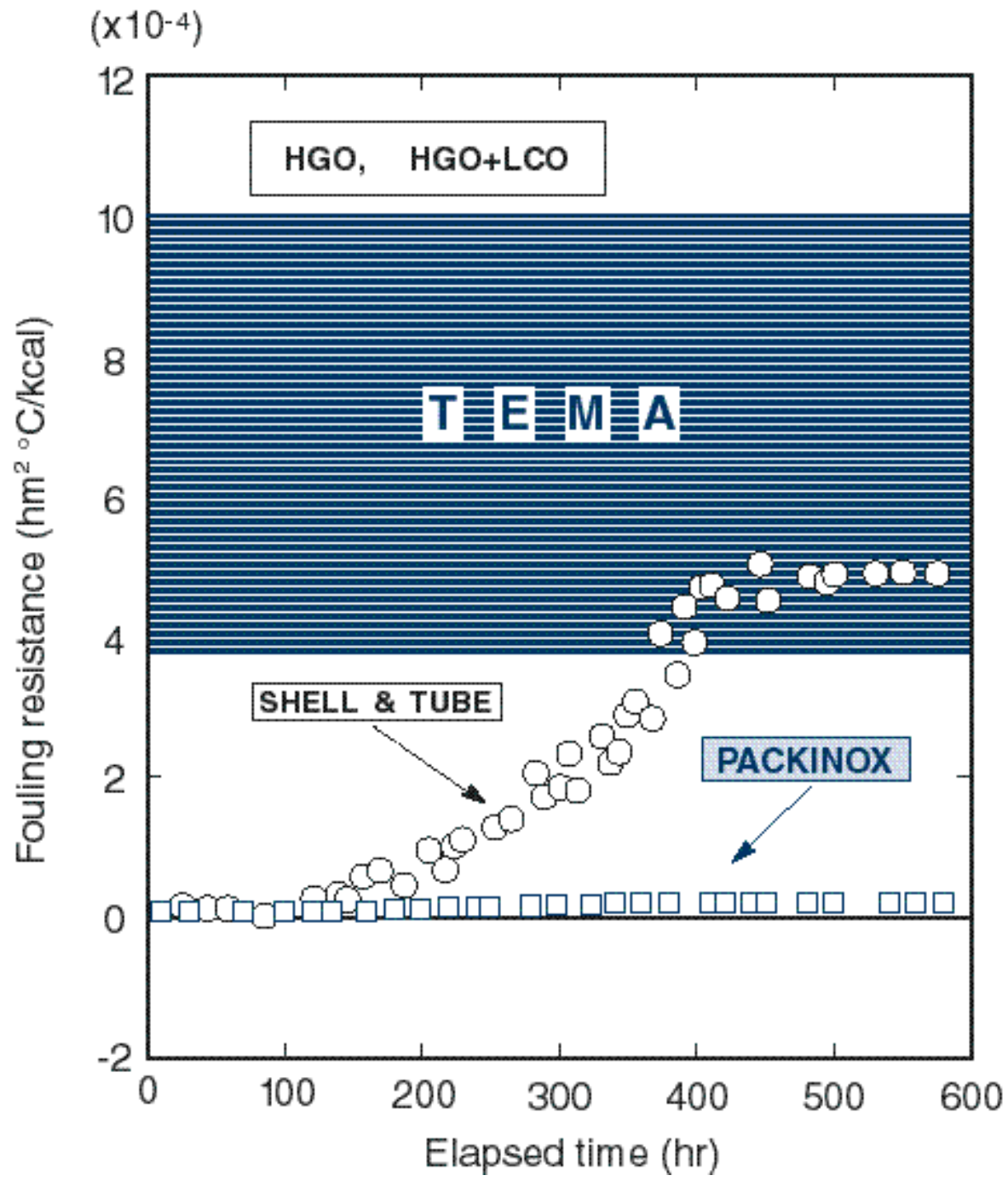

Fig 7

Gasoil HDS Packinox HE Yukos Refinery.

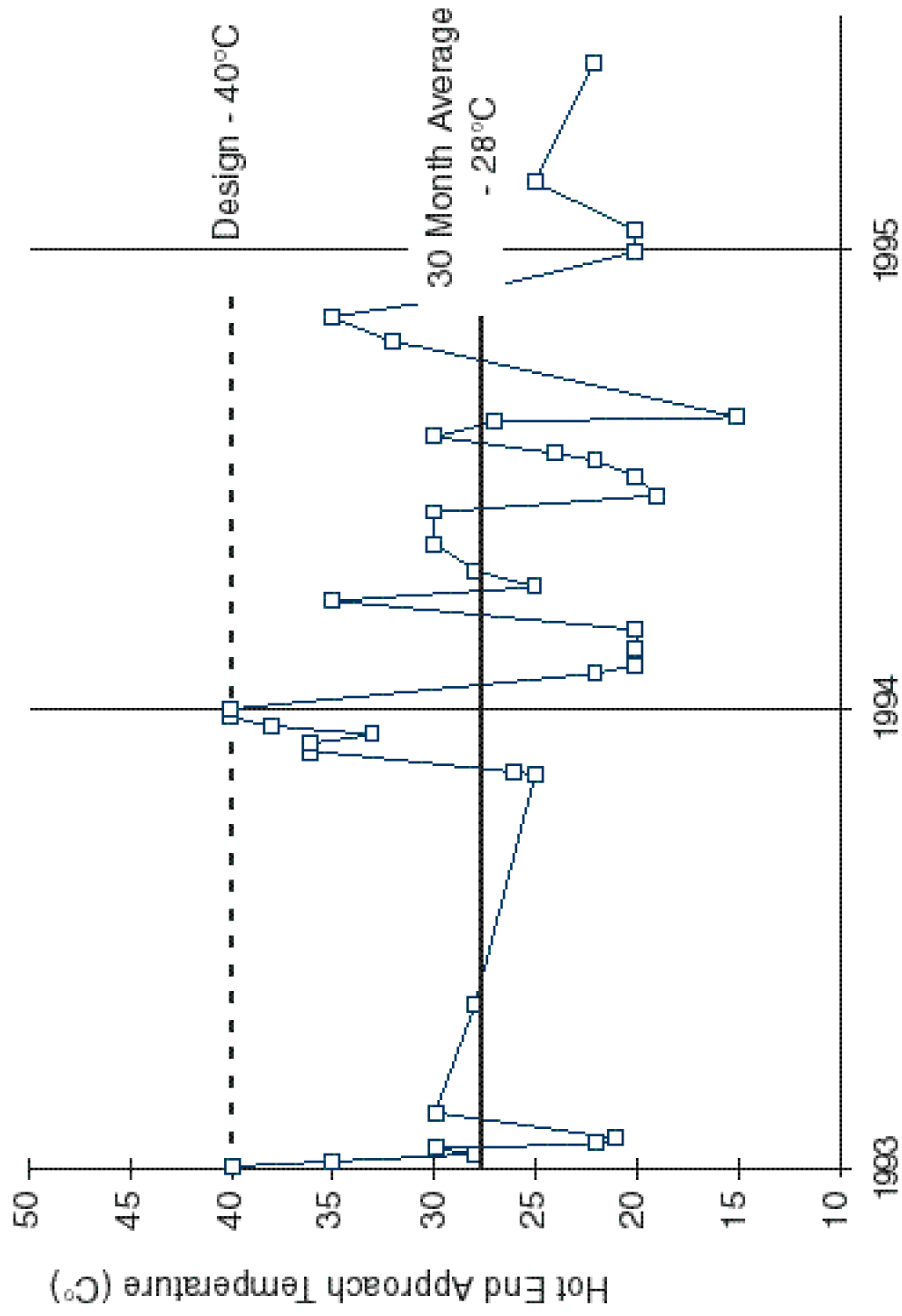
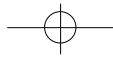

Fig 8



Corrosion Avoidance

- High Temp. H₂/H₂S attack – SS Internals
- UDC, SCC – No free-water + Cl + O₂ + Solids :
 - Feed Tank – floating roof or gas blanket
 - Surge drum / drain water
 - Strainers – Solids & scale removal
 - HCl guard bed on Fresh Gas
 - Shut Down : Wash HE both sides

Fig 9 A

Safety & Environment

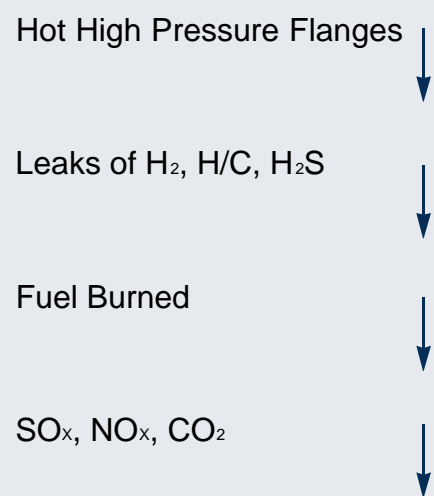
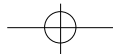

Fig 9 B



Overall Heat Balances for HDS Case Studies

Common Data:	Gasoil Feed 8600t/d	Reactor Conditions
	Diesel Prod. 8200 t/d	In / Out
	Recycle Gas 320 t/d	Temp. °C 360 / 380
	Quench Gas 210 t/d	Press. Barg 51 / 45

High Pressure Separator – Type/Temp.	Cold / 50°C		Hot / 250°	
Design Case – figure:	11 A	11 B	12 A	12 B
Exchanger Type	S-&-T	PHE	S-&-T	PHE
E1 Hot Approach Temp. (°C)	58	23	69	27
E2 Hot Approach Temp. (°C)	53	15	40	20
Reactor Circuit Total ΔP (bar)	19	11	13	9
Overall Plant Heat Balance (MW) (to nearest MW)				
Heat IN - Charge Heater	23	5	10	0
- Exotherm	22	22	22	22
- Electric Drives (P1+K1)	5	3	4	3
- Stripping Steam	3	3	3	3
Total IN	53	33	39	28
Heat OUT - E3, High Pr Condensor/Cooler	38	22	16	15
- E6, Stripper Condenser	7	7	8	8
- E7, Diesel Rundown Cooler	8	4	15	5
Total OUT	53	33	39	28
Heat to Feed Mix to reach 360°C (MW)				
- Charge Heater	23	5	10	-
- Electric Drives	5	3	4	3
- E1 , heat from diesel product	-	-	28	38
- E2 , heat from R1 effluent	68	94	57	57
- E4 , heat from diesel product	6	-	-	-
- E5 , heat from Hot HPS vapour	-	-	3	4
Total = Q_i	102	102	102	102
Heat from Reactor Effluent to reach 50°C(MW)				
- E2 , heat to Reactor feed	68	94	57	57
- E8 , heat to Stripper feed	17	7	-	-
- E1 , heat to Stripper feed	-	-	28	38
- E3 , heat to HP cooler	38	22	16	15
- E5 , heat to Recycle Gas	-	-	3	4
- E6 , heat to Stripper Cond. from oil	-	-	4	4
- E7 , heat to Diesel cooler	-	-	15	5
Total = Q_o	123	123	123	123

Fig 10

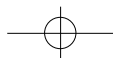

Cold Separator HDS - Shell & Tube HE.

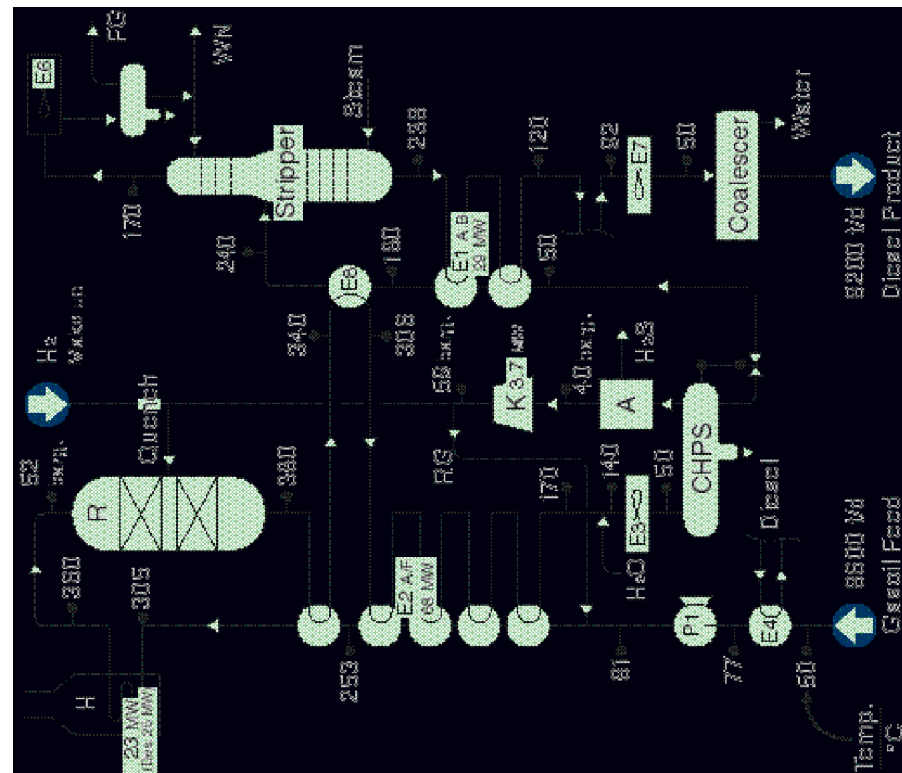

Fig 11 A

Cold Separator HDS - Packinox HE.

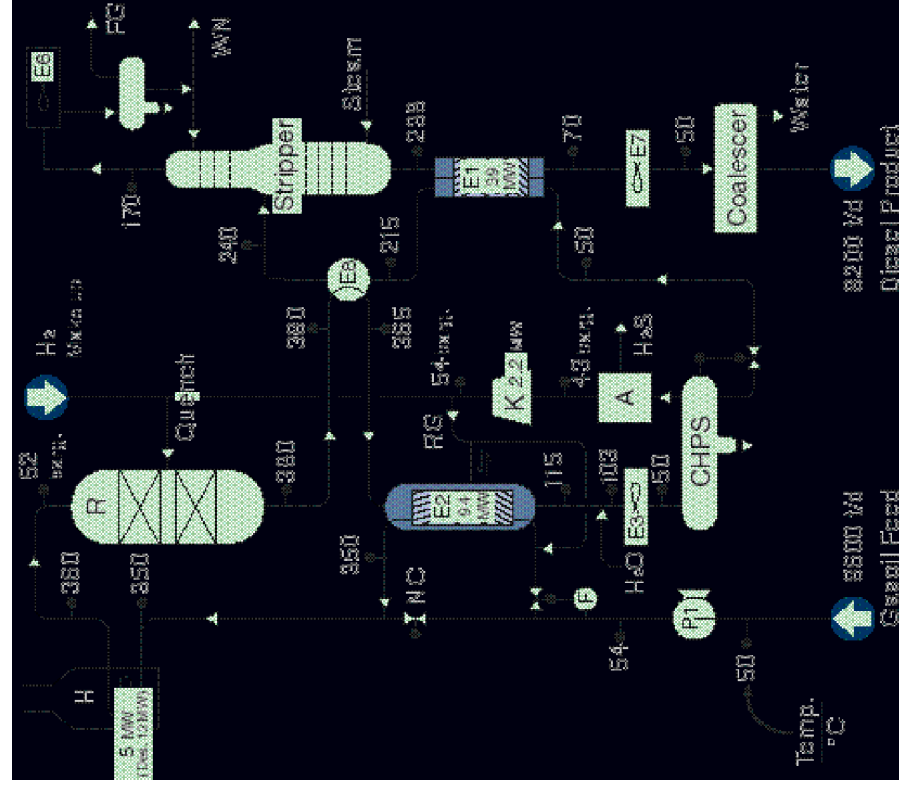
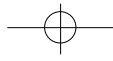

Fig 11 B



Hot Separator HDS - Packinox HE.

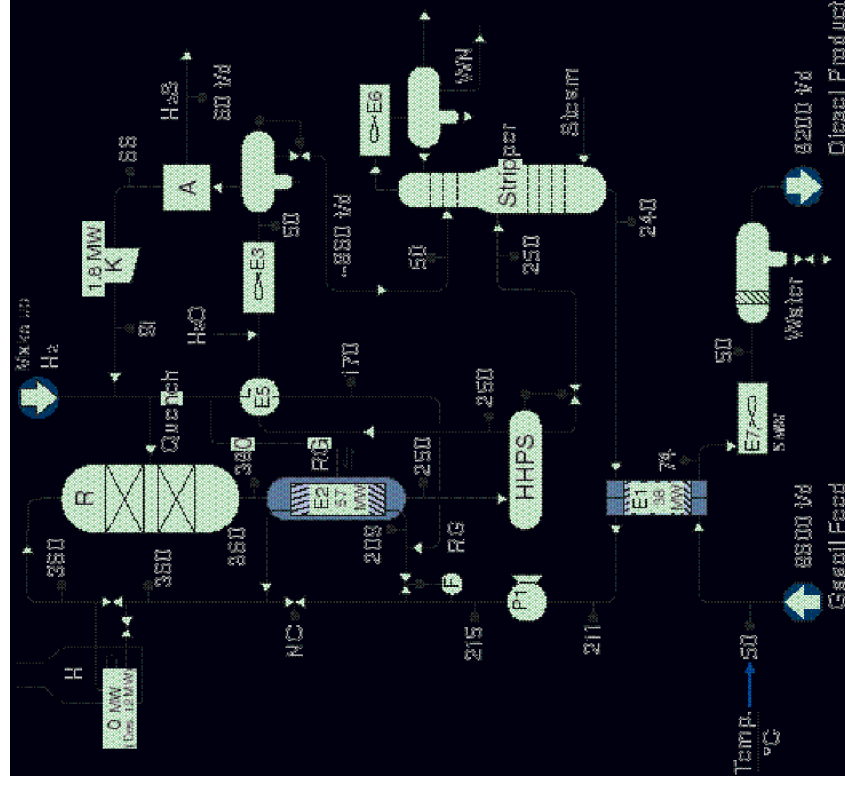

Fig 12 B

Hot Separator HDS - Shell & Tube HE.

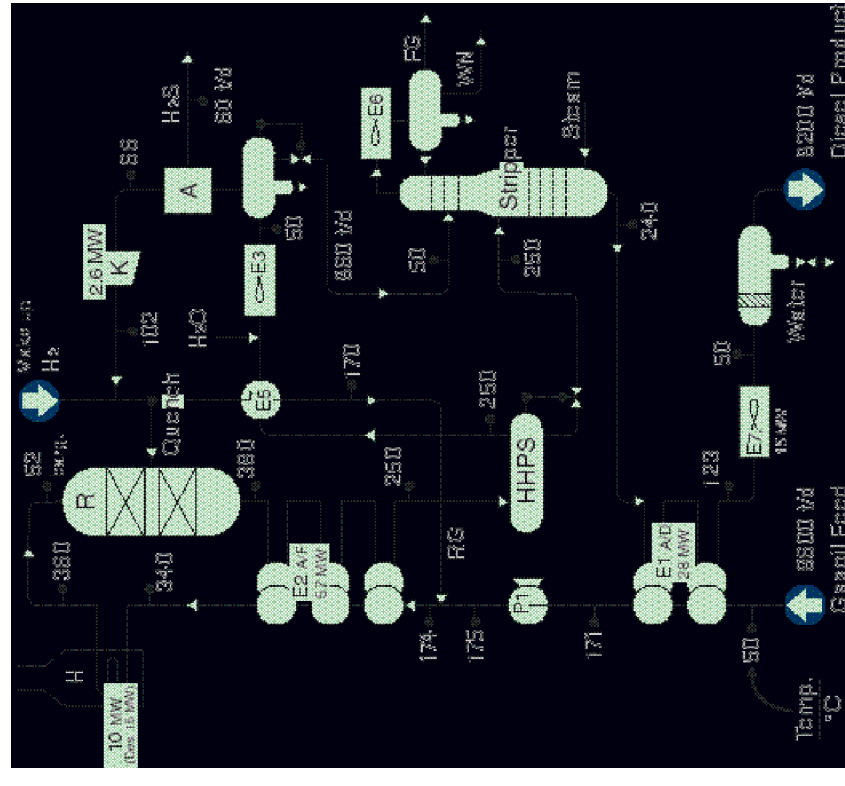
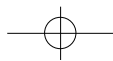

Fig 12 A



HDS Operation with Smaller Heaters

- More heat retention → Rapid Heat-Up
- F/E Bypass valve → Wide Temp. Control
- Branch symmetry → Equal flow in Heater tubes
- Adequate tube velocity → Homogenous 2-phase flow

Fig 13 A

Packinox HDS Case Studies

Case No.	Continent	Gasoil (t/d)	Energy Saved (US\$Million/y)	Capital Saved (US\$ Million)
1	Asia	8 600	3.3	7.7
2	Europe	4 800	1.3	0.5
3	Asia	5 000	2.0	5.4
4	Americas	5 100	1.6	5.1
5	Asia	4 400	0.6	1.2
6	Asia	7 500	1.2	5.0
7	Asia	1 060	0.4	1.0
8	Asia	1 060	0.2	0.7
Average		4 700 (35 000 bpsd)	1.3	3.3

Estimated "5-year total saving"
for 35 000 bpsd HDS:
Typical Benefit = (1.3 x 5 + 3.3) = US\$ 10Million

Fig 13 B

Enercon Incentive Cold HPS – Case Study

	Shell-&-Tube	Packinox PHE	Saving
E1 approach (°C)	58	23	
E2 approach (°C)	53	15	
HP Circuit DP (bar)	19	11	
Charge Heater (MW)	23	5	18
RC Gas Comp. (MW)	4	2	2
Σ Fuel & Elect. (MW)			20
Energy (US\$Million/y)			3.3

Fig 14 A

Installed Capital Cost - Case Study

Equipment	Change	Δ US\$ Million
Large Exchangers – N°	8 -> 12	0.9
Heater Design – MW	25 -> 12	2.2
Cooler Design - MW	50 -> 37	2.7
Comp.+Motor - MW	4 -> 2	1.9
<u>Total</u>		<u>7.7</u>

5-year Total Saving = US\$ 24Million
(Revamps also cheaper)

Fig 14 B

European HDS Revamp

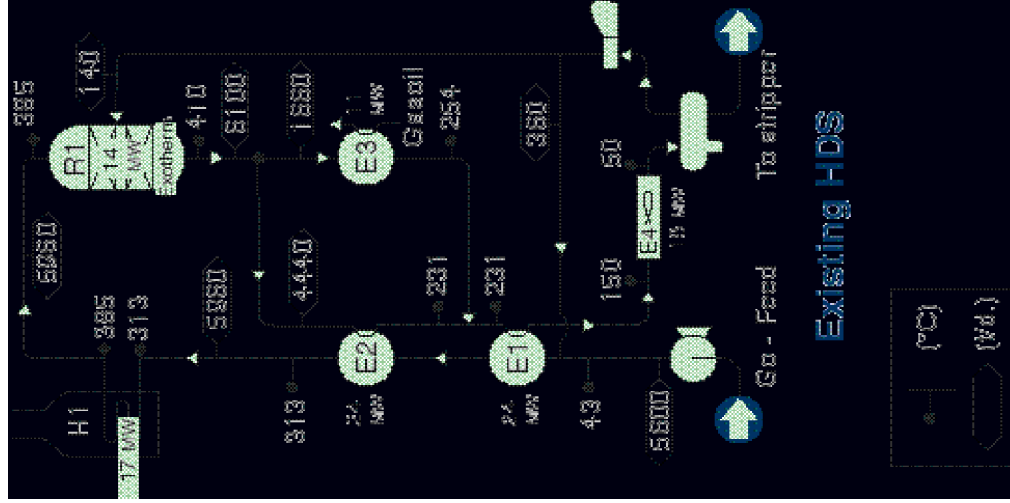

Fig 15 A

European HDS Revamp

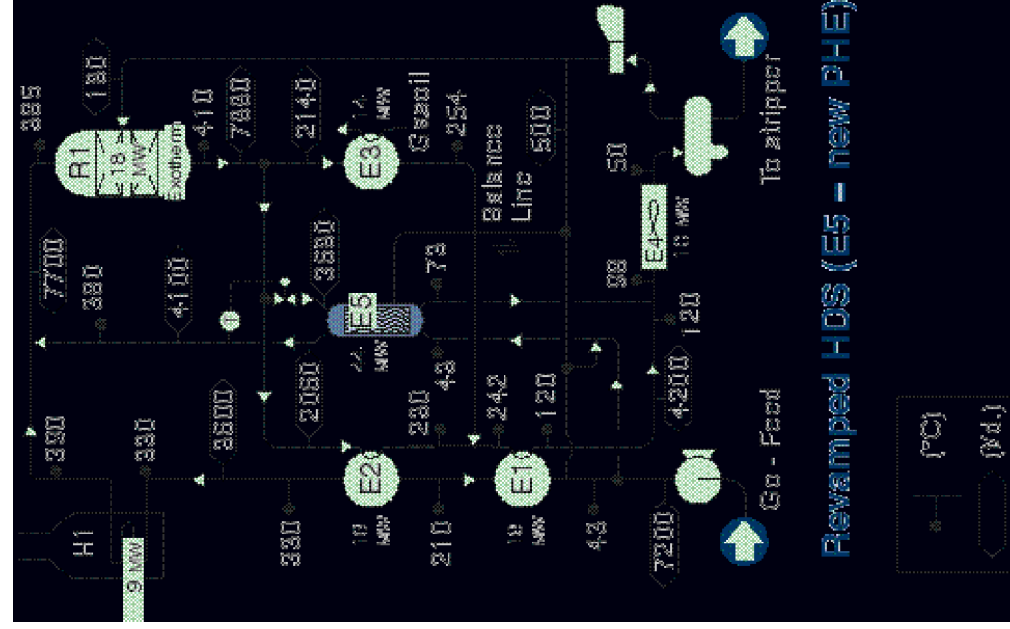

Fig 15 B

HDS Revamp Case Study - Reactor Circuit Heat Balance

Revamp Study Case	Existing HDS	Shell-&-Tube Revamp	Packinox Revamp
Gasoil Feed Rate (tonnes/day)	5 600	7 200	7 200
Overall Heat Balance - base 43°C (MW)			
IN			
- Fired Heater	17	17	9
- Reactor Exotherm	14	18	18
Total Heat Sources	31	35	27
OUT			
- E3 – Heat to Stripper	11	14	14
- E4 – HP Air Cooler Duty	18	18	10
- V1 – Product >43°C	2	3	3
Total Heat Sinks	31	35	27
(MW) to Raise Combined Feed to 385°C			
- E1	23	20	16
- E2	25	26	16
- E5 (new heat exchangers)	-	21	43
- H1	17	17	9
Total (MW)	65	84	84
Total per 1000t/d feed (MW)	11.6	11.6	11.6
(MW) to Lower Effluent to 50°C			
- E1	23	20	16
- E2	25	26	16
- E3	11	14	14
- E4	18	18	10
- E5 (new heat exchangers)	-	21	43
Total (MW)	77	99	99
Total per 1000t/d feed (MW)	13.8	13.8	13.8

Fig 16

Hydrotreating - Packinox Welded Plate Heat Exchanger Reference List

N°	Company/User	Engineering Contractor	Location	Country	Licensor	Process	Design Conditions			Feed Flow Rate (b/d)	Start Up - Status
							New Unit or Reamp	Hot End Approach (°C)	Pressure (bar)		
21	PEMEX	Sunkiyong	Cadereyta	Mexico	IMP	Naphtha HDT	New Unit	20	74	30 000	Delivery May 1989
20	PETRO-CANADA	Cott	Cokville	Canada	-	Naphtha HDT	Reamp	35	41	12 000	Delivery Jan 1989
19	LUKOIL	SNC Lavalin	Volograd	Russia	LNK	Kerosene HDS	Reamp	24	53	20 000	Delivery Feb 1989
18	LUKOIL	SNC Lavalin	Volograd	Russia	LNK	Naphtha HDT	Reamp	30	45	18 000	Delivery Feb 1989
17	LUKOIL	SNC Lavalin	Volograd	Russia	LNK	Naphtha HDT	Reamp	30	45	10 000	Delivery Feb 1989
16	FORMOSA Petrochem 2	FRG / CTCl	Mai Liao	Taiwan	FPF	Gasoil HDS-Stripper	New Unit	20	20	65 000	Delivery Dec 1988
15	FORMOSA Petrochem 1	FRG / CTCl	Mai Liao	Taiwan	FPF	Gasoil HDS-Stripper	New Unit	20	20	65 000	Delivery Dec 1988
14	FORMOSA Petrochem 2	FRG / CTCl	Mai Liao	Taiwan	FPF	Gasoil HDS-Reactor	New Unit	15	64	65 000	Delivery Dec 1988
13	FORMOSA Petrochem 1	FRG / CTCl	Mai Liao	Taiwan	FPF	Gasoil HDS-Reactor	New Unit	15	64	65 000	Delivery Dec 1988
12	PEMEX	Protexa	Madero	Mexico	IMP	Naphtha HDT	New Unit	49	41	45 000	Delivered Sep 1988
11	YUKOS	In house	Syzran	Russia	LNK	Naphtha HDT	Reamp	30	45	16 200	Delivered Sep 1988
10	PETRO-CANADA	In house	Montreal	Canada	-	Gasoil HDS	Reamp	28	59	18 000	December 1987
9	SAMSUNG Chemicals	Samsung	Daesan	South Korea	UOP	Naphtha HDT	New Unit	50	43	29 000	July 1987
8	NAFTA	Lengui	Mezėikai	Lithuania	LNK	Naphtha HDT	Reamp	40	31	33 000	October 1986
7	PEMEX	Mecanica de la Pena	Salina Cruz	Mexico	IMP	Naphtha HDT	Reamp	49	77	29 000	January 1987
6	MTSUI	JGC/Mitsui Sekka Eng	Chitba	Japan	FPF	Pyrolysis Gas. HDT	Reamp	38	34	10 000	August 1985
5	SIDANCO	Lengui	Argansk	Russia	LNK	Naphtha HDT	Reamp	44	32	32 000	September 1986
4	YUKOS	In house	Novokubyshevsk	Russia	LNK	Gasoil HDS	Reamp	40	60	20 000	August 1985
3	SLAMEET	BehnefektHim	Yaroslavl	Russia	LNK	Naphtha HDT	New Unit	35	47	11 000	August 1985
2	YUKOS	In house	Novokubyshevsk	Russia	LNK	Gasoil HDS	Reamp	40	60	20 000	December 1983
1	BRC	In house / Lummus	Antwerp	Belgium	-	Naphtha HDT	Reamp	40	55	27 000	October 1983

Fig 17

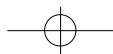

HDT/HDS Packinox Exchangers

- N° in Operation 1993-98 10
- N° Under Installation or Fabrication 11
- Total References, end 1998 21
- Total NHDT+HDS Revamps 9+4

Feed Types - Naphthas : Atm + Visbreaker Naphtha, Py Gasoline
- Gasoils: Atm + CN +LCO

Fig 18 A

Conclusions: Hydrotreater PHE's

- Efficient, Reliable, Proven
- Leak-Tight & Safe
- Ideal for Revamps
- Saves US\$ Millions – Capex & Fuel

Fig 18 B

